

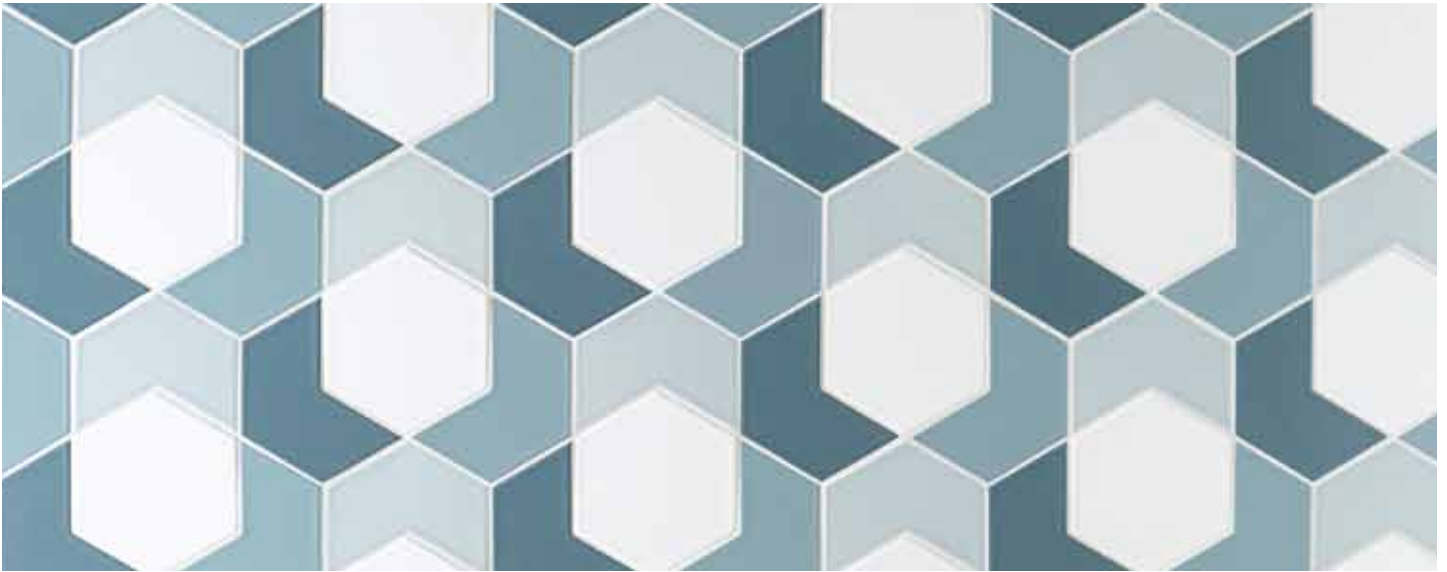

VIA

DESIGNED BY KRISTINE MORICH



Patterns in our built environment create character, tell stories, and bring spaces to life. Tile can take an ordinary wall from a flat plane to a surface with depth and character. The Via collection, designed by Kristine Morich, draws on a rich history of decorative tilework found in the Andalusian region of Spain. The striking geometric patterns of Via merges Spanish motifs with contemporary style.

The Via Collection is composed of only four tile shapes—the hex, diamond, small dart, and large dart. But with this simple assortment, sixteen different patterns can be created, and when combined with our extensive palette the variations are endless.



# Pattern Guide

---

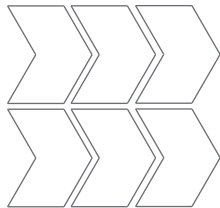

A

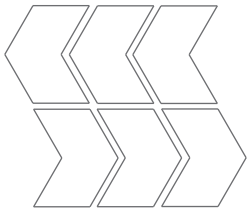

B

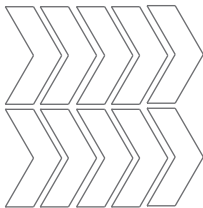

C

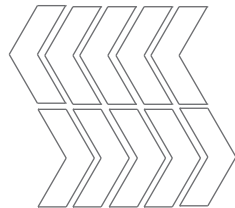

D

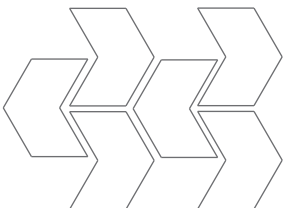

E

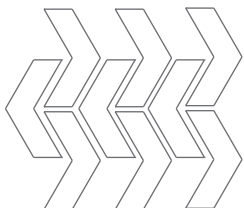

F

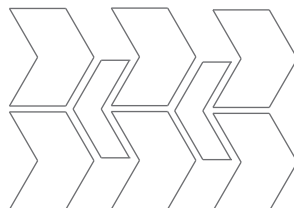

G

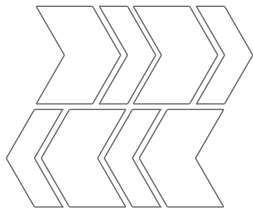

H

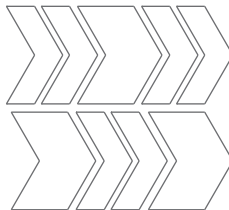

I

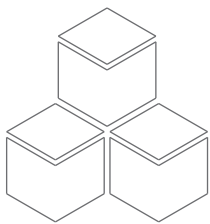

J

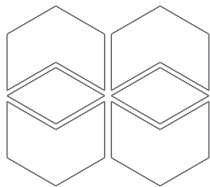

K

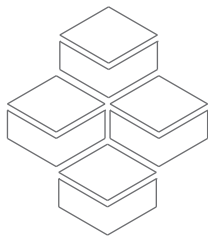

L

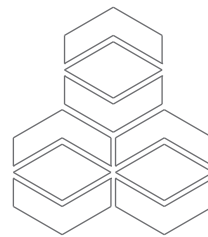

M

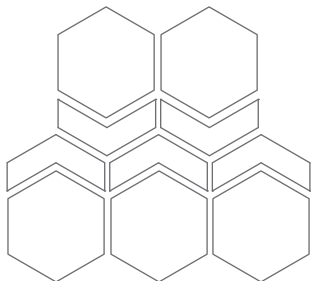

N

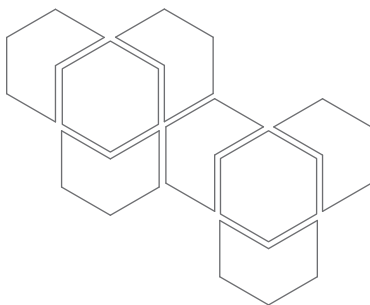

O

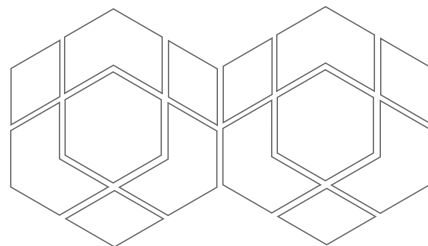

P



VIA

DESIGNED BY KRISTINE MORICH

---

SMALL DART

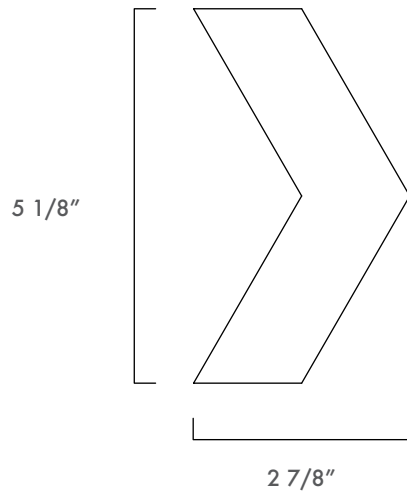

LARGE DART

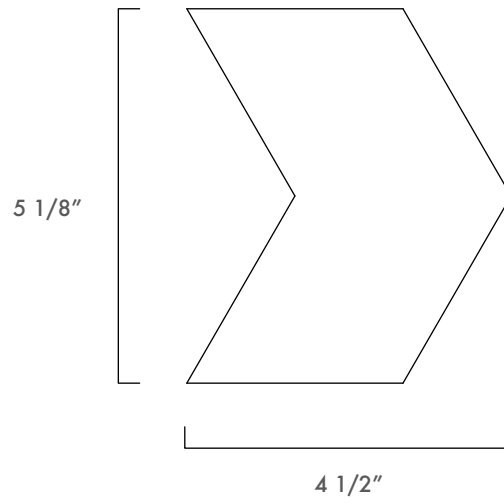

HEX

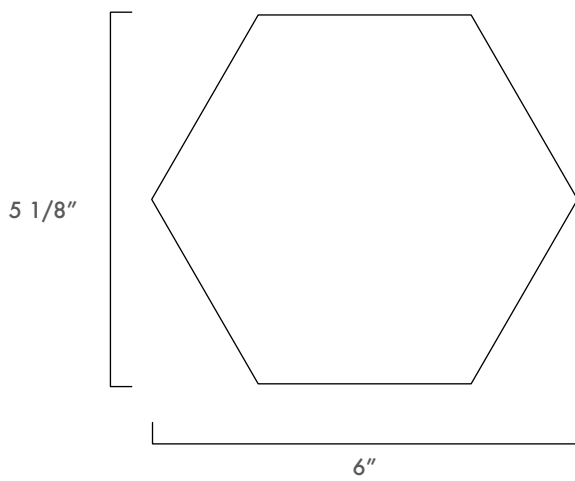

DIAMOND

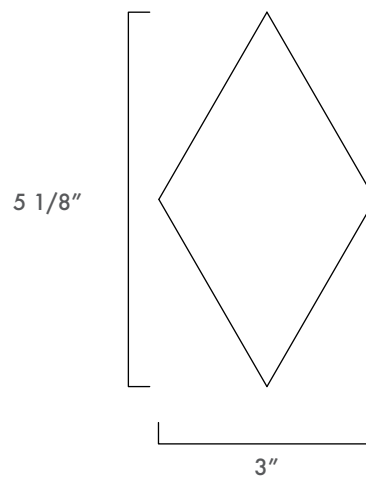

## General information

---

collection	Via
designer	Kristine Morich, 2021
application	wall – indoor residential/commercial
material	glazed white earthenware clay
thickness	5/16"
sizes	Hex, 6" x 5 1/8" Diamond, 3" x 5 1/8" Small Dart 2 7/8" x 5 1/8" Large Dart 4 1/2" x 5 1/8"
recommended joints	3/16"
minimum order	10 sq ft
pricing	All patterns are priced and sold by the square foot Please inquire by phone or email for quotes and samples

---